

X55 ENJOY YOUNG AND FUN



BAIC

X55 II Overview

Target Customer Early Adopter to Technic and Fashion

Product Position A Grade Smart SUV

Basic Parameter 4620*1886*1680/2735mm
1.5T+7DCT

USP

Design	Power	Intelligence	Safety	Quality
Crystal Star Design	Core Power	ADAS	C-NCAP 5 Star	Comfortable Driving
Crystal Diamond Interstellar Cabin	Dual "Top 10" Power 100km accelerator 7.84S SMART Drive Mode WLTC Consumption 6.9	Advanced Driving Assistance System APA Auto Parking	C-NCAP 5 Star Design Robotech Body Design Comprehensive Safety Design	Healthy Cabin Inductive Panoramic Sunroof Hidden Door handle Smart Tail Gate

▶ Product Selling Point



Crystal Star Design



BEIJING

CHINESE AESTHETICS IN NEW ERA



Design Theme

CRYSTAL STARS



▶ Colors



Light Sculpture Surface

Pure Curve Design

Creates a dramatic flow built of light and shadow

Using fluent lines to emphasis side shape of X55 II, the light and shadow corresponded under daylight, and the color transition is very smooth.





Inductive Hidden Door Handles

Popped out door handle like a handshake

Hidden door handle equipped on all series

- **Supercar door handle design:** greatly reduces the side wind drag coefficient and improves fuel economy
- **Automatically pop out:** When approaching the vehicle with the key, the vehicle automatically unlocks and pops out the handle; When leaving the vehicle, the vehicle automatically locks and closes the door handle;
- **Ice-break mode:** After rain or snow, if the door handle is frozen, the electric lock will automatically trigger three hits to break the ice and ensure the useage of the car



Experience: Approach the vehicle and watch it pops out



Split tail

From aerodynamics

Pretty modeling, excellent turbulence performance of the split design



Makes your high-speed driving more steady

- At high speed driving, it can effectively guide airflow and improve vehicle stability



0.32 Super Low DC

Super low DC, New limit of SUV



Experience: Fuel economy

Best in the same level

- **0.32 DC** , super low drag coefficient
- Build on many details, **boundless low dc grille, high slope windshield, streamer surface, split tail, hidden door handle, hidden wiper, flat chassis** etc.
- When driving in rainy weather, **the windshield leaves less rain**, and the windows on both sides of the main and front passenger are cleaner, which improves driving safety



Flat Chassis

魔方	Q5	X5	GLC	卡宴
0.32	0.33	0.31	0.31	0.35

Interstellar Cabin

Interior Lighting, brighten your night



10.25' HD LCD
Instrument Panel

10.1' HD Central HD
Central Screen

Start Trails Ambient Light

Colorful light strip+ Sculpture door sheet
Build up a diamond feel ambient light

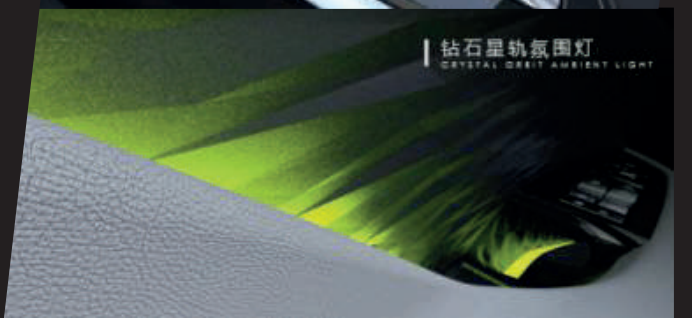
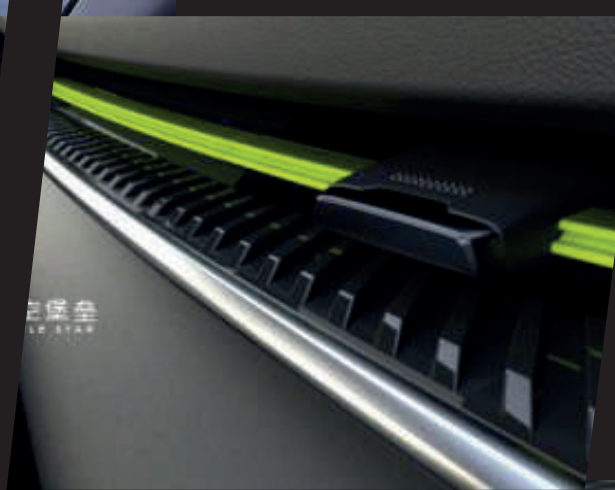

▶ Product Selling Point



Core Power



Double "TOP 10" Power

Fast feedback power train, economic and efficient

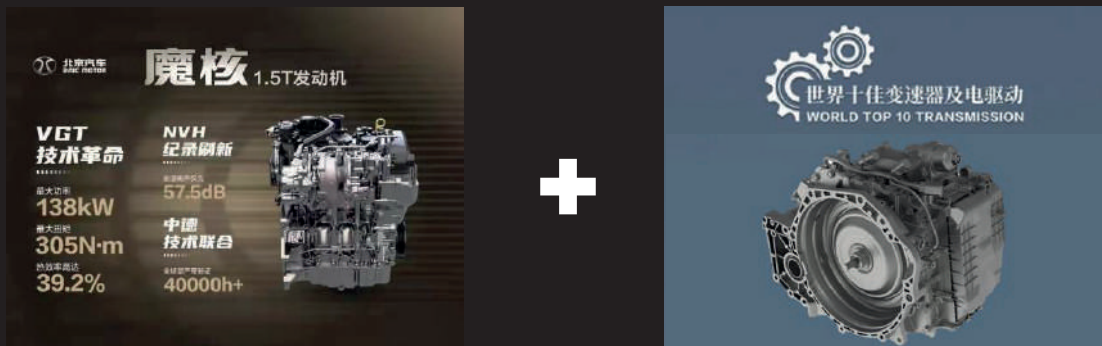

魔核 1.5T发动机

VGT 技术革命
最大功率 138kW
最大扭矩 305N·m
热效率高达 39.2%

NVH 纪录刷新
57.5dB
中德 技术联合
40000h+

世界十佳变速器及电驱动
WORLD TOP 10 TRANSMISSION

S劲 U智 P静 E省 R韧

0-100KM accelerate **7.84s**

100km braking range **35.6m**

100km consumption **6.9 L**

Comprehensive acceleration benchmark **Benz GLC**

VGT Supercharger

Lightweight Design

350bar+High Flow Ratio

380NM Max Torque

Miller Circulation

Cylinder block cylinder head split cooling

Efficient energy saving configuration

Double "TOP 10" Power, highest torque within A class					
Model	X55 II	ChanganUNI-T	MG one	Haval H6	CRV
Prize	Dual Top 10	Top 10 Motor	Top 10 Motor	N/A	N/A
Emission	1.5TD	1.5TD	1.5TD	1.5TD	1.5TD
Power/KW	138	132	133	124	142
Torque/N·M	305	300	285	285	243

0 delay for overtaking



Time to feel young again

Most economic model



Dual top 10 power train plus smart driving, best fuel economy within A class



Dual "Top 10" Awarded Powertrain

“中国心”2021年度
十佳发动机评选
获奖机型

北京汽车
魔核
1.5T发动机

TEN
BEST
ENGINES
2021

推荐车型
北京魔方

获奖理由
魔核1.5T发动机采用VGT可变截面增压器，具备低速响应快，高速动力强劲的特点，超宽转速范围内305牛·米最大输出扭矩确保动力随叫随到。缸体和缸盖水道独立控制分流冷却，同时采用行业最浅缸体水道，大幅提升泵机速度。应用16项深度减摩措施及对整机VH的极致追求成就了其卓越的综合品质。

汽车动力网
“中国心”年度十佳发动机评选组委会

2021 Annual
China Heart Top
10 Motor

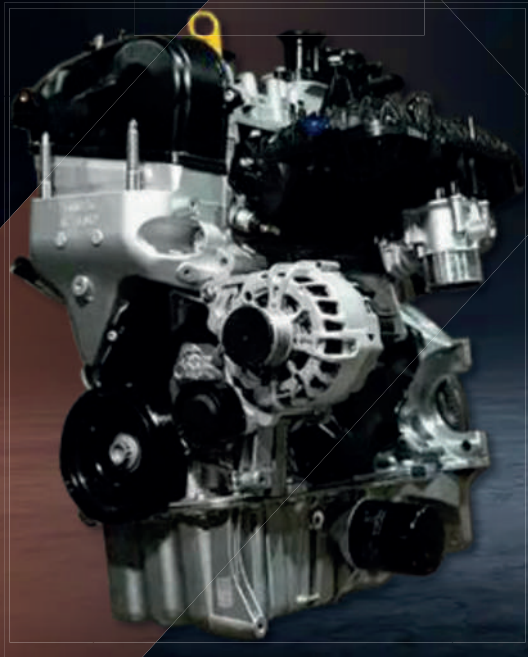

Magic Core1.5T

2022 Annual
LongPan Cup Top 10
Transmission

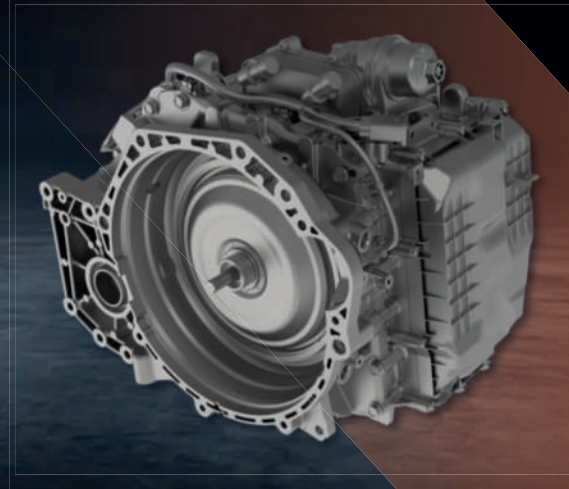

DCT 380





Magic Core 1.5T Motor

China Heart Top 10 Motor

BAIC and Germany Meta Co-Developped

39.2% thermal efficiency

VGT Technology

Miller Circulation

High Tumble Ratio

350Bar Jet Grouting

21 Noise Deduction Tech

40000h+ temper

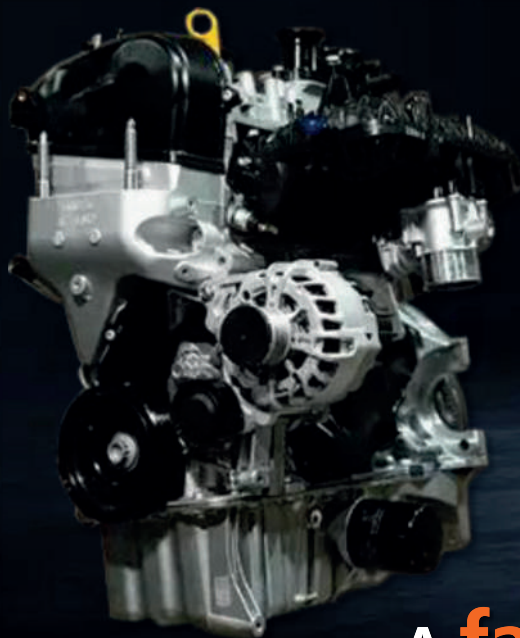

A fast-running, fuel-less, quiet and reliable Top 10 Motor

Model	BAIC Magic Core 1.5T	Changan Blue Vail 1.5T	Haval 1.5GDIT	VW 330 2.0T	BMW X1 2.0T
Max Power	138kW	138kW	135kW	137kW	141kW
Max torque	305N·m	300N·m	275N·m	320N·m	280N·m



Magic Core 1.5T Motor

VGT Supercharger Technology

Run fast, and faster!

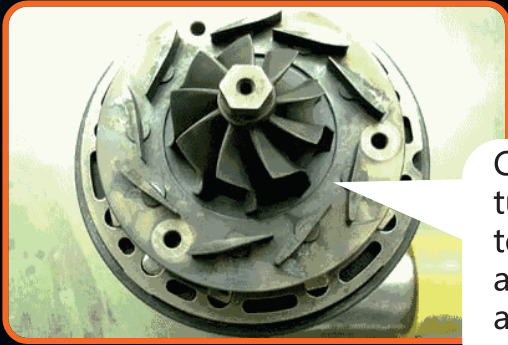

Compared with ordinary turbines, Sino-German technology combination adds blades with variable angles to achieve variable cross sections.

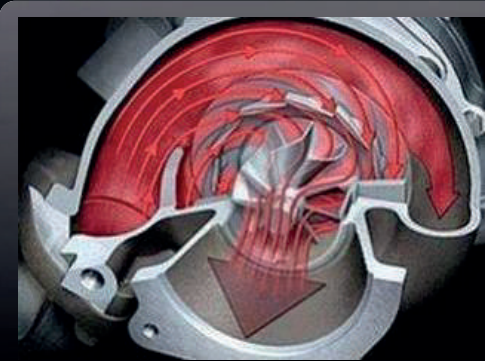

At low speed, exhaust gas flow rate is increased through decreasing the section size to increase the turbine speed, so that the turbocharging efficiency is improved

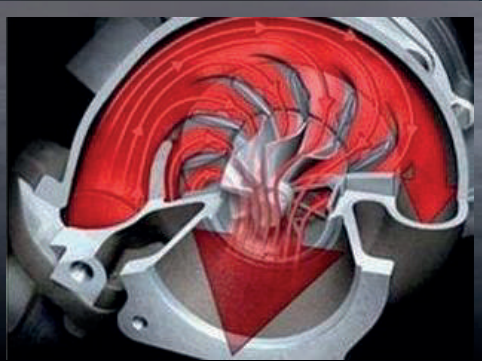

At high speed, the cross section is enlarged, the exhaust resistance is reduced, and the power output is larger



Increase 43% low speed response time

- The engine achieves a maximum torque of 305 nm at 1500 RPM
- 1500-4250 RPM wide range torque platform

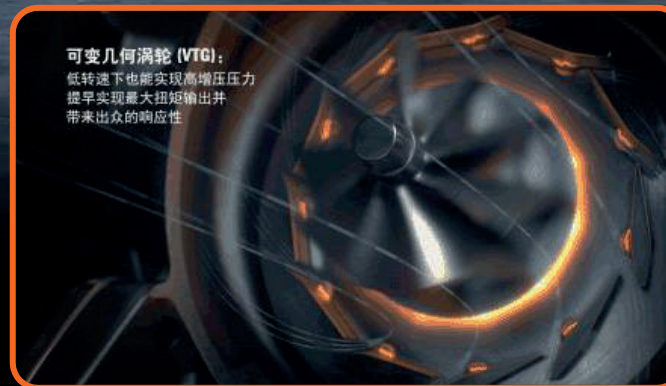

可变几何涡轮 (VGT):
低转速下也能实现高增压压力
提早实现最大扭矩输出并
带来出众的响应性

0-100km Accelerate

Quick start/ Easily overtaking

Item	Throttle Opening	BMW-X1	X55 II
Start acceleration response time (accelerated speed 0.03g time)	25%	≤0.35	0.22
	50%	≤0.25	0.12
	75%	≤0.20	0.10
Overtake accelerated response time (60km/h accelerated speed 0.03g time)	50%	≤0.45	0.36
	75%	≤0.25	0.28

Start/Accelerate outperformed BMW-X1

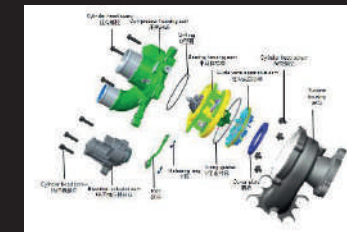
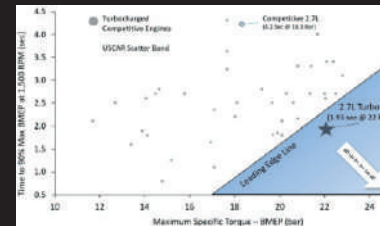
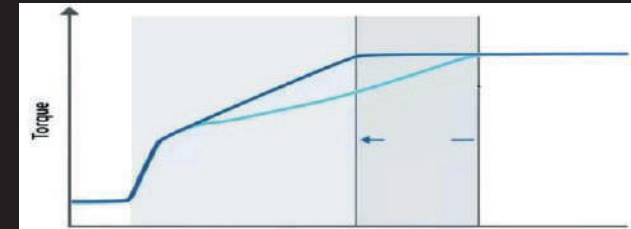

Performed better than competitors in A Class

Model	X55 II	Changan UNI-T	MG one	Haval H6	CRV
100km accelerate/S	7.84	7.97	8.1	10.05	8.81
100km braking/M	35.6	36.33	37.11	37.19	35



7.8s 1-100Km Acceleration

You can see other cars only in your rearview mirror



X55 II 1.5T

7.84s

7s Club Member Strongest Power in A Grade
Benchmark BBA 2.0T Power Level



BoYX 1.8T

9.06s



M* ONE 1.5T

8.59s

*Above data are all measured values

SMART Driving Mode

Satisfied the needs of the driver by automatically shifting to suitable driving mode, convenient and comfortable

SMART Driving Mode

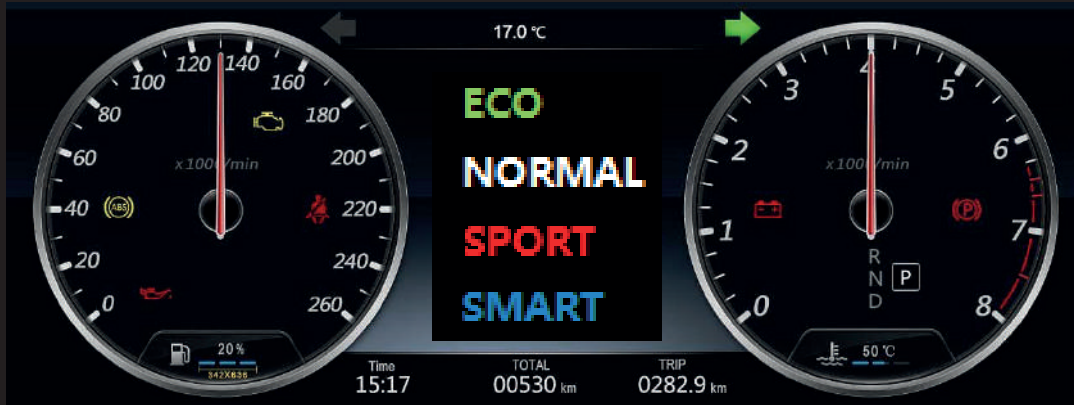

According to the driver's throttle pedal opening intelligent recognition of the driver's intention, automatically switch the required driving mode.

Driving Mode Memory Function



With the memory function of driving mode activated, when the car is turned off under ECO and NORMAL mode, the mode will continue activating when you start the vehicle again.

The first model who carries driving mode memory and SMART driving mode

Model	X55 II	Haval H6	UNI-T	GS4	RX5plus	Tiguan L
Memory of driving mode	Yes	N/A	N/A	N/A	N/A	Yes
ECO	Yes	Yes	Yes	Yes	Yes	Yes
NORMAL	Yes	Yes	Yes	Yes	Yes	Yes
SPORT	Yes	Yes	Yes	N/A	Yes	Yes
SMART	Yes	N/A	N/A	N/A	N/A	Yes (Customized)

Road Condition-Driving Behavior-Driving Mode



Be a car that understand you most: Offer you the best driving experience

Fuel Economy

Low DC Design combined with strong power train

F

Lowest consumption in A Class

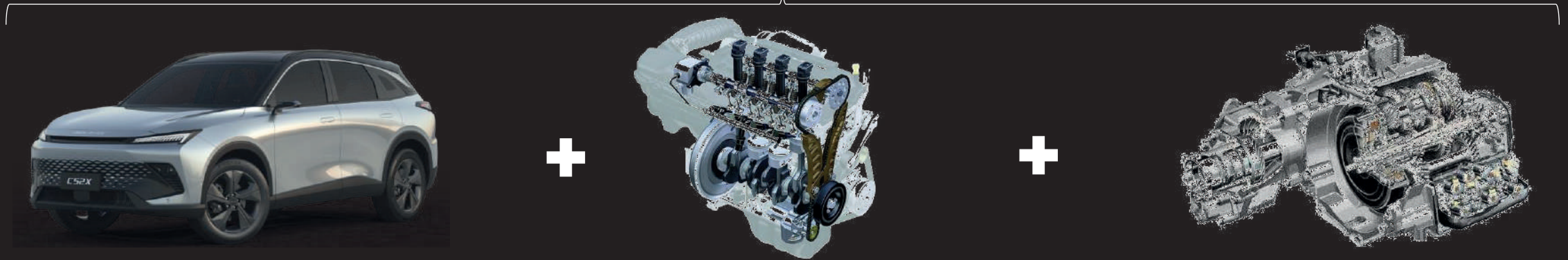

Ultra low DC 0.33

39.2% Engine thermal efficiency

Advanced transmission efficiency

Fuel-Efficient

Shift as you wish

Lowest WLTC Consumption

Model	X55 II	Changan UNI-T	Haval H6	CRV
Consumption	7.25	7.5	8.55	7.0
DC	0.33	0.35	0.37	0.33

Multiple Driving Mode



Comfort, Economic, SAMRT, Sport mode, satisfy all your needs.

▶ Product Selling Point



ADAS



ADAS

Multiple sensors and assist driving functions

- 1 brand new parking domain controller
- 1 Bosch 5th generation millimeter wave radar
- 5 driving and monitoring cameras
- 12 ultrasonic radars

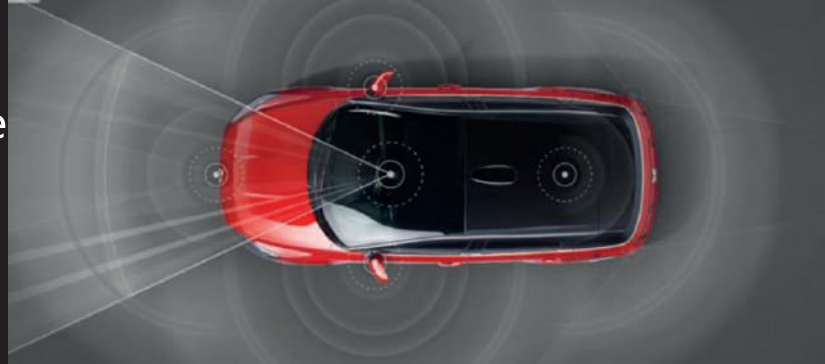

- 360° panoramic image
- AEB (Automatic Emergency Braking)
- IACC (Intelligent adaptive cruise control)
- Lane keeping assistance
- APA (One button control automatic parking System)

360° follow-up 3D panoramic image

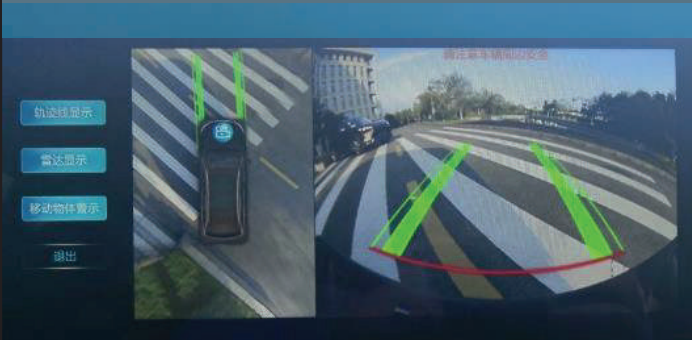

Through 4 megapixel HD cameras, collect images around the vehicle body, and provide images and reversing track lines when reversing to assist in accurate parking.

Comfortable intelligent cruise



Intelligent cruise can be started during long-distance driving, and you can easily follow the car in front without stepping on the accelerator.

Comforting low-speed traffic jam assistance



When the low-speed **traffic jam assistance** is turned on, the vehicle can automatically follow the traffic flow, and the vehicle can drive normally in the lane, which is very convenient.

APA Automatic Parking Assistance

Multiple scenarios

Stored 5 topographic maps, available in multiple parking scenario date, up to 90% parking completion rate.

Intelligent planning, low speed object avoidance

Based on sensors and related algorithms, APA can calculate the optimal parking path, automatically detect the low speed object and make braking avoidance accordingly.

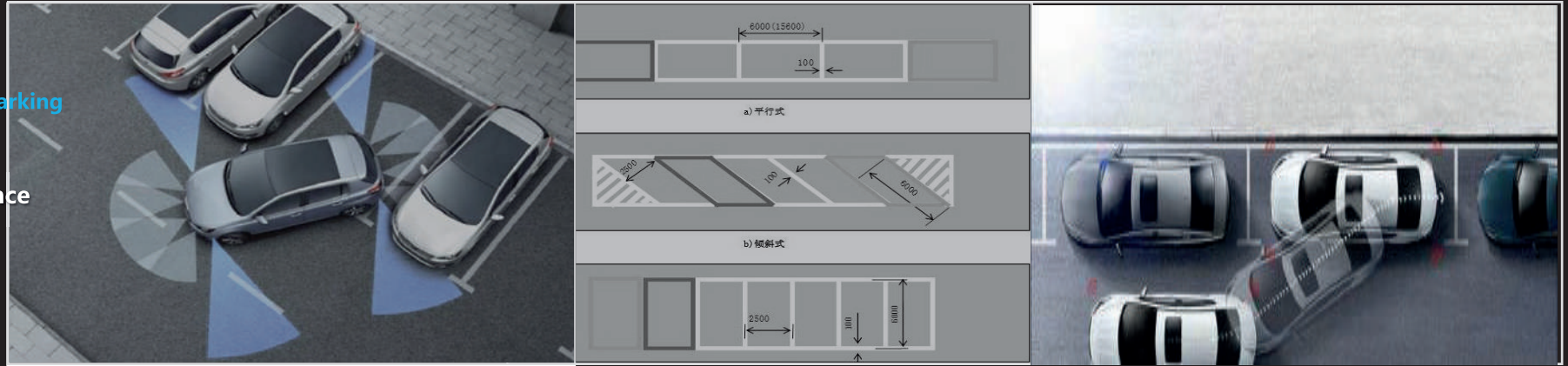

Automatic Emergency Braking(Persons/Vehicles)

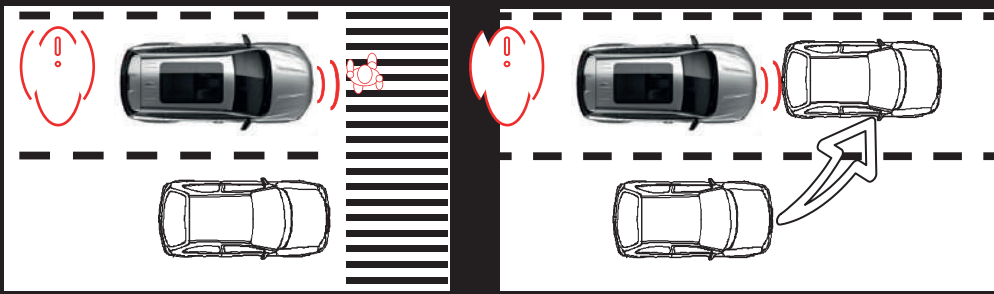

When there is a risk of collision with vehicles or pedestrians are close to the front, AEB will turn on the alarm state. After receiving the signal, the icon flashing and sound alarm are activated for warning. If the driver does not respond to the above warning (including visual warning, auditory warning and short braking warning), the automatic emergency braking system will be active to avoid collision.

Lane keeping assistance

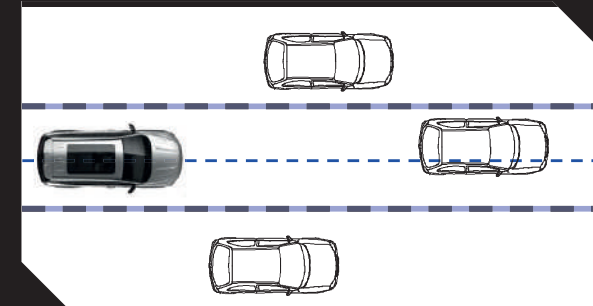

Measure the distance and orientation of the vehicle relative to the lane edge detected by the camera, provide steering control for the driver and keep the vehicle driving in the lane.

AEB Autonomous Emergency Braking

Safety guaranteed, no rear-end

Identify the pedestrian or vehicle ahead, if there is a collision risk, the system will issue an alarm, actively apply braking force, so that the speed is significantly reduced, and the driver could have more reaction time to prevent collision or reduce the injury caused by the collision

Emergency Brake ahead



Identify vehicle, passenger and bicycle

Children suddenly appeared



- Wider range
- Identify still objectives within 5-60km/h speed
- The use of front Angle radar can improve the recognition and braking of lateral moving objects
- Worked together by millimeter wave radar and forward-looking camera, when the distance from the vehicle or pedestrian in front is less than a safe distance, the vehicle can actively brake, so as to reduce collision accidents and protect life safety

* If the driver steps on the brake pedal, steps on the gas pedal with big foot, turns the steering wheel and other actions during the AEB triggering process, the system will judge that the driver is taking active measures, and the AEB function will exit and the vehicle will no longer be controlled to slow down

▶ Product Selling Point



C-NCAP Five Stars



Safety—C-NCAP 5 Star

Double safety test and five-star standard escort

C-NCAP five-star standard (Version 2021)

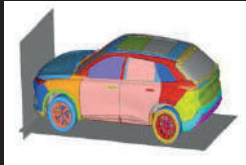

50kph front crash

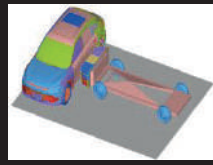

50kph side crash

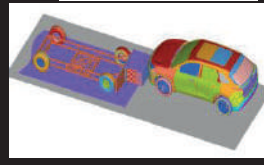

50kph MPDB



Pedestrian protection head crash

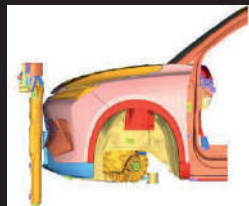

Pedestrian protection legs crash



Seat whipped

C-IASI (Version 2020)

- Front crash 25% bias
- Side crash
- Roof strength test
- Seat / headrest test

中国保险汽车安全指数
CHINA INSURANCE AUTOMOTIVE SAFETY INDEX

侧面碰撞		总体评价等级
评价项目	评价结果	
车辆结构		G
驾驶员防护		
头部运动保护		G
头部和颈部		G
躯干		G
骨盆和腿部		G
乘员防护		
头部运动保护		G
头部和颈部		G
躯干		G
骨盆和腿部		G

Higher standards, more abundant materials, more comprehensive safety

Models	X55 II	Changan UNI-T	Boyue X	MG one	HAVAL H6
C-NCAP (Version 2021)	5 stars	5 stars	5 stars	N/A	5 stars
C-IASI (Version 2020)	Class G (5 items)	N/A	N/A	N/A	Class G (4 items)

The most advanced insurance in times of emergency.

In case of an emergency, the structural design of the vehicle, side crash and head safety protection will save the lives of drivers and passengers in times of emergency.

Comprehensive Protection Design

Space fortress body design



The body stiffness is 21872, which can strengthen safety protection in crash reduction and deformation.

New X55 II

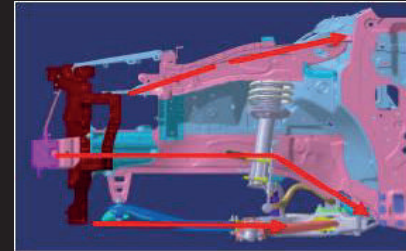

- ✓ There are three longitudinal force transmission paths in the front cabin, which is conducive to dispersing the force. There are only two Uni-t.

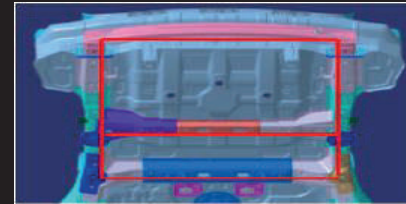

- ✓ Compared with uni-t single beam, double beam closed structure provides strong support.

UNI-T

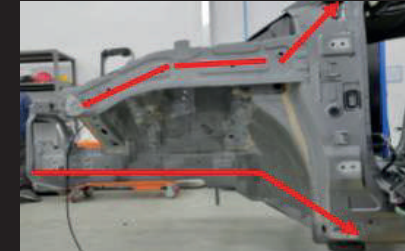

Excellent structure, large quantity, high strength and abundant materials

Models	X55 II	Changan UNI-T	MG one	HAVAL H6	Honda C-RV
车身扭转刚度 N·m/deg	21872	19200	18000	19000	19000
防撞梁截面尺寸 (mm)	111*45*1.5	100*30*1.2	100*30*1.2	100*30*1.2	100*50*1.5
前后门双加强梁	2	1	1	2	3

Passive safety protection system



6 airbags in all directions to reduce the degree of casualties.

▶ Product Selling Point



Comfortable Driving



Healthy and quiet mobile space

Environmentally friendly and tasteless



Front insulation pad



Carpet mat

The benzene is **25%** of the national standard.

The formaldehyde is **10%** of the national standard.

Antibacterial steering wheel



The bacteriostatic rate was **99.9%** (Staphylococcus aureus, Escherichia coli and pneumoniae)

Antibacterial handlebar grip



The noise isolation of the whole vehicle is more than **25 dB**, and the noise in the vehicle is less than **67 dB** at a constant speed of 120KM/ H.



29 sound absorbing materials

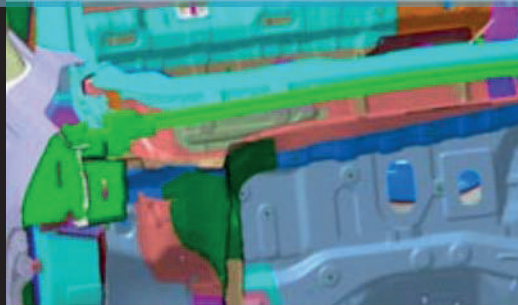

26 cavity partitions

First-class cabin seat enjoyment - comfortable and powerful functions



Heating, ventilation and electric lumbar support

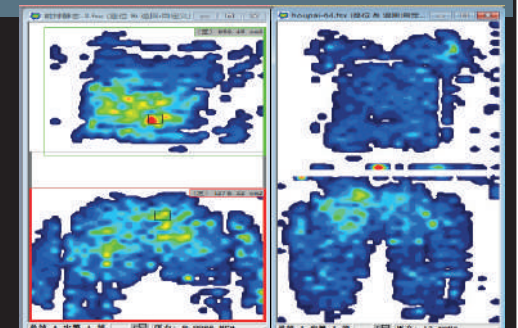

Multi gradient foaming hardness calibration

Induction Panoramic Sunroof & Hidden Door Handle

The high-tech sunroof from Inalfa has a large light transmission area and can auto-sensing rain and close.

Inalfa-tech • Large light transmission area

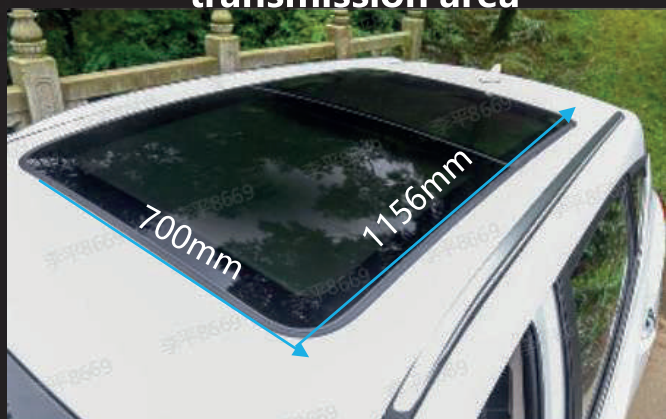

Self-induced closure during rainy weather



Advantages: The light transmission area is the largest among competitors, and it is also the only model equipped with the function of automatically closure sunroof in rainy days.

Models	X55 II	Changan UNI-T	Boyue X	HAVAL H6	CRV
Transmission area	0.81m ²	0.73m ²	-	0.82m ²	0.53m ²
Rainy days Automatic Closure	YES	N/A	N/A	N/A	N/A

Attractive appearance with the sense of ritual to provide you a fully satisfaction of both the internal and external!

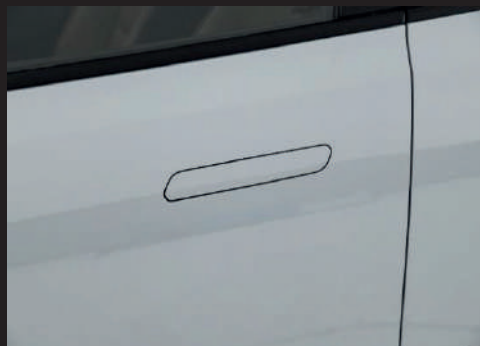

Attractive appearance
low wind resistance

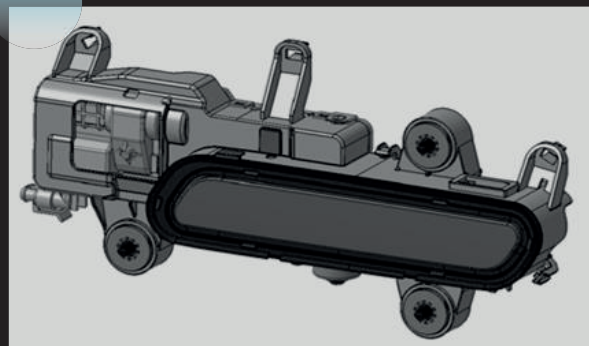

High cost: about 30% higher than mechanical door handle.



Don't worry about freezing in winter.

Intelligent welcome mode

Ice-breaking mode

Automatic locking function after leaving

Touch, automatically popup

Multiple functions:
Integrates four functions

Intelligent tailgate

No More Manually Operation——Intelligent Tailgate



Dual-drive electric struts
37.2mm in diameter.



Intelligent induction entry



Delayed off

A: Dual-drive electric struts, 37.2mm in diameter, with intelligent entry, demonstration closing, remote control opening and closing functions

Models	C52X	Changan UNI-T	HAVAL H6	CRV
Structure	Dual-drive	Single-drive	Single-drive	Gas spring
Struts diameter	37.2mm	36	36	18
Intelligent entry	Yes	N/A	N/A	N/A
Delayed off	Yes	N/A	N/A	N/A

B1: Delay off·Saving Time and comfortable

You can remove things at any time without having to manually close it.



B2: Induction open· Effortless

The tailgate will open automatically when the key stays at the back of the vehicle for 4 seconds.



THANK YOU!

BAIC

 BAIC JORDAN | www.baicjo.com